

Water Chiller Owner's manual

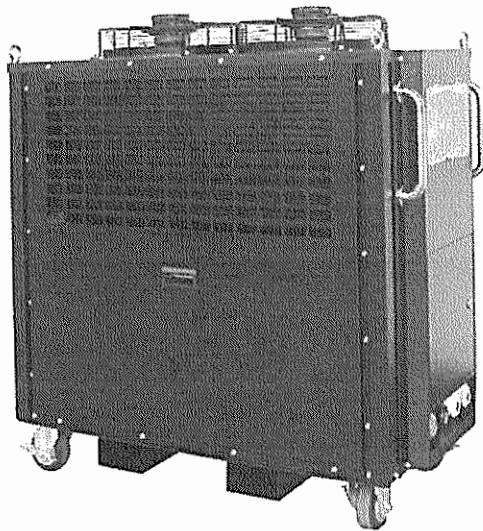

AMERICOOOL

Specifications of Weltem Chiller (60Hz)

Specification	Model	WWC-500
Cooling capacity	BTU	61,500
Power supply	Phase	3 phase
	Volt	208-230
	Hertz	60
Size (W X D X H)	Mm	680 x 1240 x 1320 (h)
Weight	Kg	240
Current consumption	Amps	22
Power consumption	Kw	4.8
Compressor	Type	Scroll
Pump	HP	1
Design flow rate	GPM	14.5
Minimum flow rate	Liter	30L / MIN
Maximum flow rate	Liter	145L / MIN
Refrigerant	Type	R-410A
Operating condition	°C	10~45
Water tank capacity	Liter	66
Pipe connection (Supply / Return)	Inch	1

Safety devices

Unit photo

Compressor time delay
 Compressor overload protection
 High pressure switch
 Anti-freeze Thermostat
 Emergency stop
 Floating valve in the tank
 Flow switch for pump
 Fan controller (ON/OFF)
 Self-diagnostic function
 Automatic restart

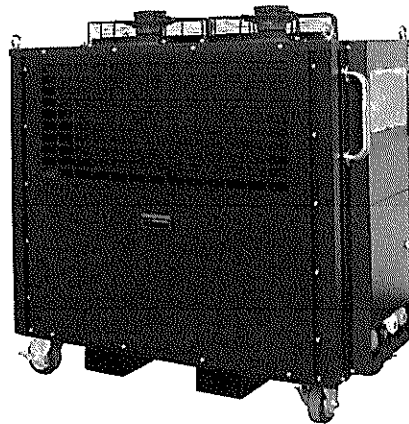

1	Index
---	-------

Caution before using	03
Product features	06
Caution while maneuvering	07
Instruction for installation	08
Controller manual	10
Instruction & caution for running	12
Maintenance	14
Self-diagnostic code	15
Circuit diagram	17
Model specification	18

2 Caution before using



Caution

Make sure to follow these safety tips to use the machine properly and prevent any accident.

- Check the power source's voltage.
(to prevent fire, electric shock)

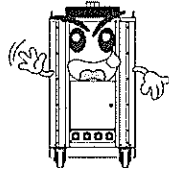

- Use the proper power cord for the machine.

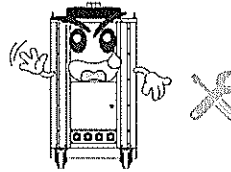

- Do not place and use any flammable material near the machine.
(to prevent fire, damage to the machine)

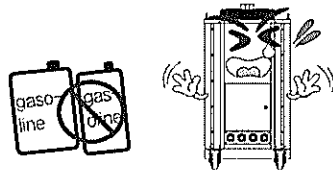

- Do not spray and wipe water, benzene, thinner alcohol directly to the machine
(to prevent fire, electric shock, damage to the machine)

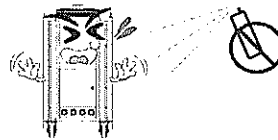

- Do not force the power cord to bent or have it pressed by heavy stuffs.
(to prevent fire, electric shock)

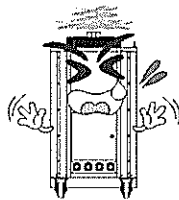

- Do not install the machine near the stuffs easy to burn like curtain, blanket, clothes.
(to prevent fire)

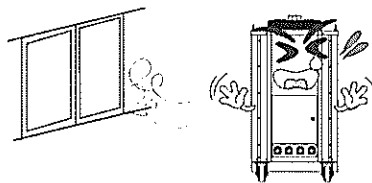

2 Caution before using

 **Caution** Make sure to follow these safety tips to use the machine properly and prevent any accident.

· Do not block the air inlet & outlet port,

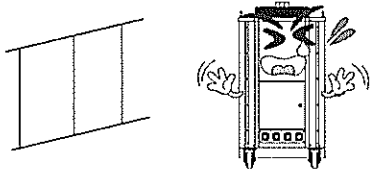

· Do not get the eyes near the air outlet port while running to prevent the burnt from the heat,

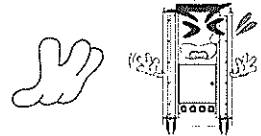

· Do not let external substance go into the air inlet & outlet port.
(to prevent malfunction)

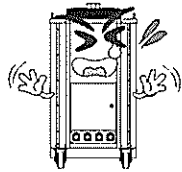

· Make sure to use a proper relay to the machine.
(to prevent fire, electric shock)

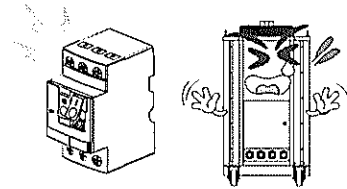

· When not using for a long time, drain out the remaining water inside the machine using drainage valve and place the machine avoiding hot and humid place.
(to prevent freeze of the inner component)

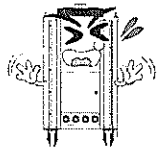

· Make sure to manage the water always clean.

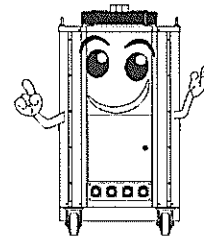

2 Caution before using



Caution

Make sure to follow these safety tips to use the machine properly and prevent any accident.

- Do not use or touch the damaged power cord.
(to prevent fire, electric shock)

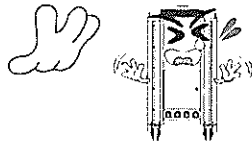

- Make sure to have the power source is connected only with this machine.
(to prevent fire, electric shock)

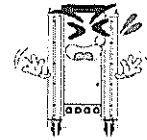

- Do not use or touch the damaged power cord.
(to prevent fire, electric shock)

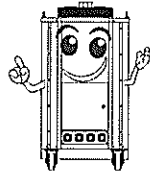

- Make sure to do the grounding of the machine.
(to prevent fire, electric shock)

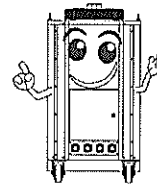

- Do not open the covers while running.
(to prevent fire, electric shock)

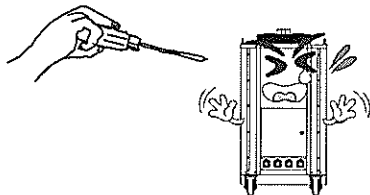

- Never disassemble, repair, modify the machine by your own.
(to prevent fire, electric shock, Contact the service center for the maintenance)

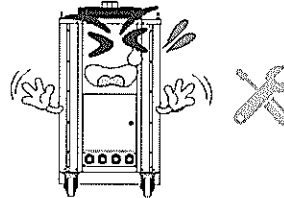

3 Product features (WWC-500)

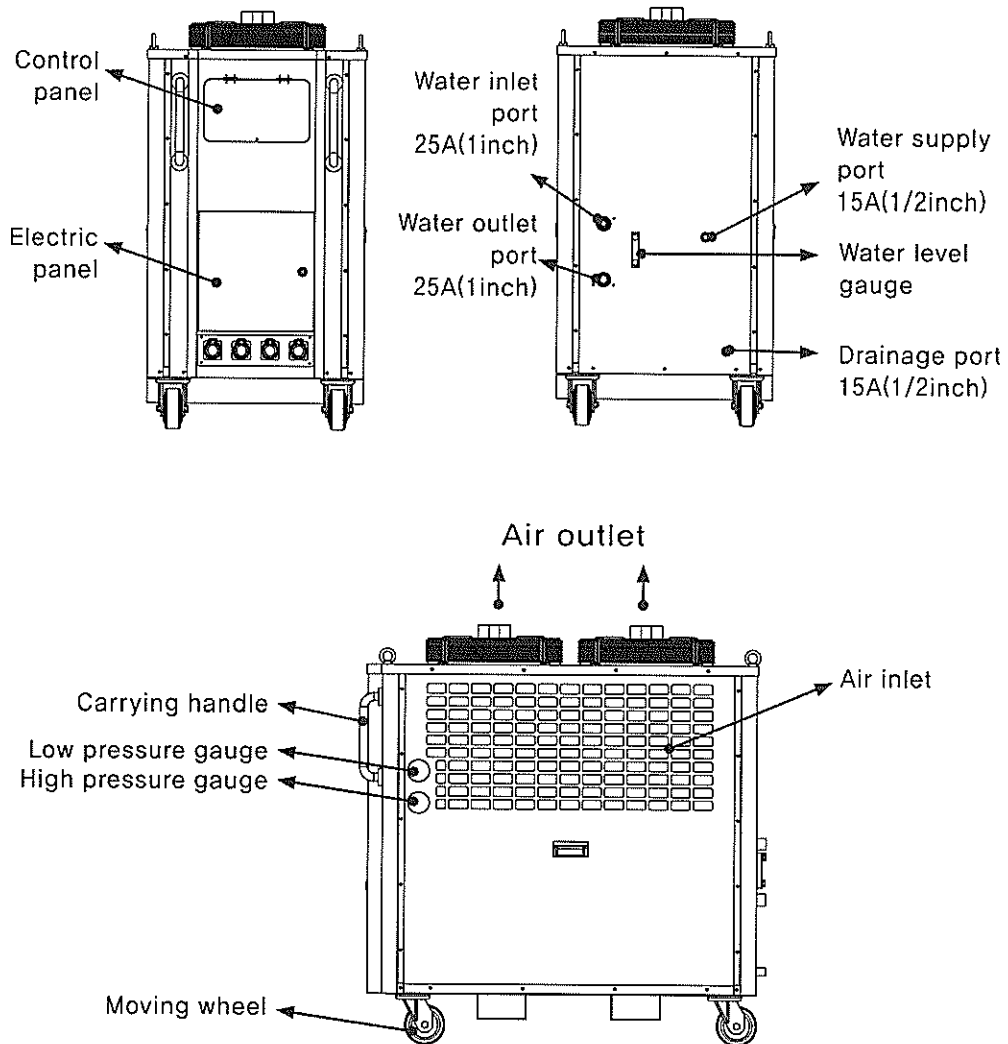

4 Caution while maneuvering

1. While maneuvering, do not tilt the unit more than 40°. Too much tilting might cause malfunction of the machine. Do not put too much vibration or shock to prevent the gas leakage. To maneuver with forklift or hoist, please refer the below picture.

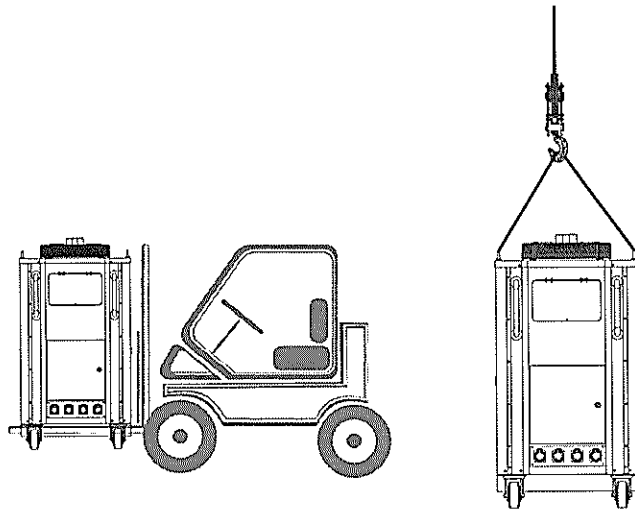

2. While using forklift
 - Make sure the machine is balanced well.
 - Make sure the fork is inserted deep enough to hold the machine stably.
3. While using hoist
 - Have the brackets on the top stay up to use hoist.
 - Use the hoist can stand more than 500 KG.
 - Make sure the machine is not tilted while using hoist.

5 Instruction for installation

[Choosing the right spot to install]

1. Do not use the machine at where explosive, flammable gas leakage might happen.
2. Install the machine at where is well ventilated and has low humidity.
3. Do not place any external substance near the ventilation port.
4. Make sure the air inlet & outlet port have enough space to suck in & pull out the air.
5. Do not install the machine at powdery, dusty, oily area.
(Do not place any external substance within 500mm from the ventilation port)

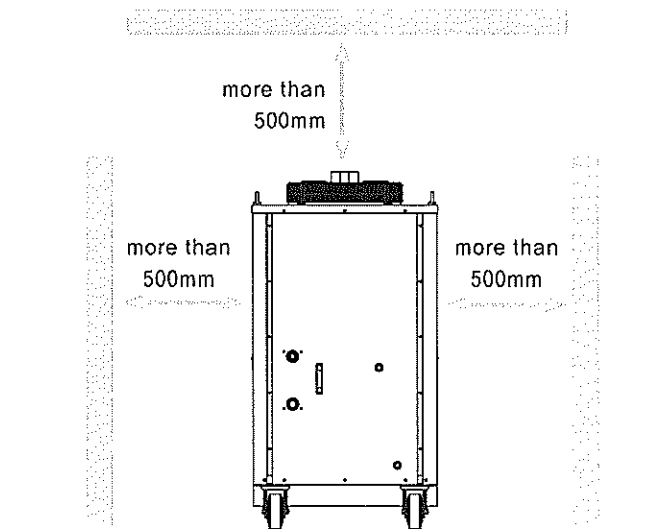

5 Instruction for installation

[Instruction for the valve connection]

1. Make sure the pressure of the inlet valve lower than 0.1 Mpa, outlet valve lower than 0.6 Mpa.
2. Check if there is no leakage on the pipe while running.
3. Check the loose of the valve connection, leakage, infiltration of air while running.
4. While installing the pipe, avoid maneuvering the valve to prevent losing the pressure.
5. Let the supply valve always open, as the machine is designed for auto-water supply system.
6. Make sure to connect the right valve of inlet & outlet port.
7. When the inner contamination is found for long-time using, drain out the water and refill it.
8. When not using for a long time, drain out the remaining water inside the machine using drainage valve and place the machine avoiding hot and humid place.

6 Controller manual

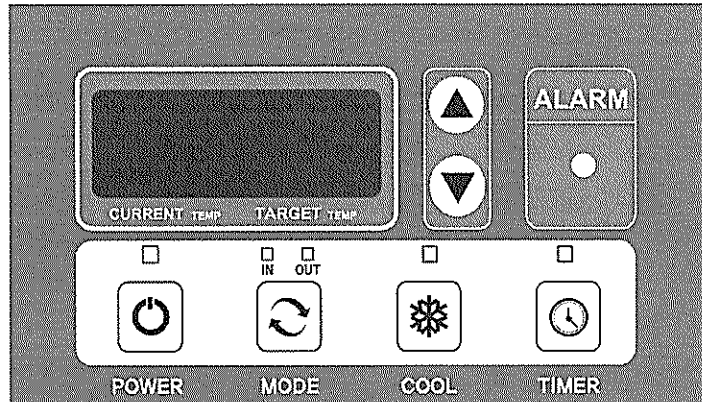

1) Power button

- Press and hold for 1 second to turn on the unit.
- Press and hold for 1 second to turn off the unit.

□ Note : When main power is on, compressor starts after 3 minutes.(Compressor protective system)



Power button LED : Showing the power is on / off.

2) Mode button

- Press the button to change the temperature sensor on inlet and outlet.
- When IN is on, the display shows inlet water temperature.
- When OUT is on, the display shows outlet water temperature.

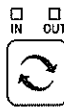

□ □ Press the button to change the temperature sensor on inlet and outlet (IN ↔ OUT)
By pressing the button, you can set the target temperature.
(41~86°F(5~30°C))

6 Controller manual

3) Cool button

- Press the button to select the cooling mode.
- When current temperature is higher than target temperature, the cooling starts. When current temperature is lower than target temperature, the cooling stops.

□ LED ON : Cooling on



LED OFF : Cooling off

(compressor stops, condenser fan stops, drainage pump starts)

4) Timer button

- Press the button to set the off-timer.
- The setting value is from 30 minutes to 12 hours.

□ LED ON : Off-timer on



LED OFF : Off-timer off

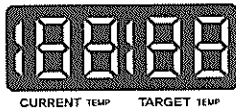

[hour] [minute]

▲ After set the desired time, leave the unit not manipulate for 5 seconds to exit the setting mode OR press COOL button to exit immediately.
▼

- Display shows [current temperature, target temperature] for 5 seconds and switch to [remain hour, minute] for 2 seconds.
- When off-timer triggers to off the machine, the machine goes into stand-by mode.

5) Cancel the off-timer

- By turning off the machine pressing POWER button, the off-timer will be cancelled.
- Enter the off-timer mode, set the value as '___', '___' to cancel the off-timer.
- When the unit is shut down by external accident, the remaining time is memorized in the system when turning on again.

7 Instruction & caution for running

1. Before initial start, fill up the tank with clean water (distilled water).
(subterranean water might cause blocking of the pipe and multiple malfunction)
2. Recommended water is distilled water and tap water.
 - Mixing ratio (prevent freezing maximum -2°C)
distilled water : 90wt%, Antifreeze : 10~20wt%
 - (If the ratio is not correct, the circulation pump might have leakage.)
3. For the initial running, connect the valve and open it.
The water will be supplied automatically.
Check the water level gauge and run the machine.
4. Refer the picture below to check and supply the water.

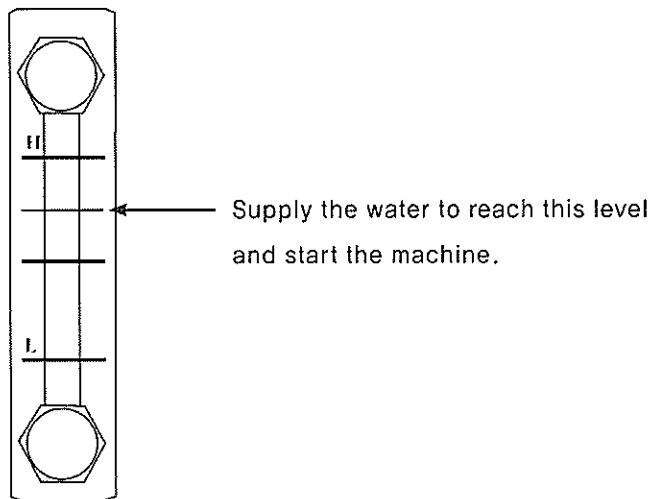

7 Instruction & caution for running

5. Never run the machine without the water.
This will damage the water pump.
6. Make sure the air not to go into the water pipe.
7. The compressor protective system will delay the initial start of the compressor.
8. Do not put in fingers or tools through the ventilation port.
9. Do not put any kind of substance that has a chance to drop into the unit.
10. Do not place any kind of external substance near the ventilation port.
11. Make sure not to have your face near the air outlet to avoid any burnt from the heat.

8 Maintenance

1. For the maintenance, cut off the power to the machine in advance.
2. Never do the maintenance while the machine is running.

This cause various accident.

[Cleaning the condenser]

Use the air gun or brush to clean the fin of the condenser.

Make sure not to bend or damage the fin.

Furthermore, do not use iron brush, it might damage the fin.

[Water Tank]

1. Make sure to manage the water to be clean.
2. Clean the water inlet & outlet valve once every 6 months, to prevent any sludge blocking the pipe.
If the pipe or valve is blocked, it will make a loud noise and worsen the performance.
4. During the cold season, it is recommended to use anti freeze like ethylene glycol to prevent freezing to burst.







[For long time storage]

1. Make sure to cut off the power.
2. Put the cover on the machine to prevent any external substance to infiltrate into the unit.
3. Make sure to manage the condensers not to have dust or oil mist on the surface.
4. Make sure to drain out all the water remaining inside the machine.

9 Self-diagnostic code

Alarm display	Problem	Cause	Corrective action
	Reversed phased	<ul style="list-style-type: none"> · Power cable is connected wrongly 	<ul style="list-style-type: none"> · Reconnect the power cable R,S,T correctly
	Compressor overload	<ul style="list-style-type: none"> · Ambient temperature is too high · Unstable power supply · Compressor failure 	<ul style="list-style-type: none"> · Do not run the machine when ambient temperature is higher than 113°F(45°C) · Reset the relay and check · Contact the qualified service agency
	Water pump overcurrent	<ul style="list-style-type: none"> · Pipe blocked · Losing pressure of the pipe · Damage of the bearing of the motor or pump 	<ul style="list-style-type: none"> · Inspect the blocking and clean it out · Contact the service agency
	Fan motor over current	<ul style="list-style-type: none"> · Unstable power supply · Crack on the fan or Stuck · Damage on the bearing 	<ul style="list-style-type: none"> · Replace the fan motor · Contact the service agency · Reset the relay and check
	Water tank shortage	<ul style="list-style-type: none"> · Losing of flow in the circulation system · Flow switch failure · Water shortage of the evaporator · Blocking of evaporator or condenser 	<ul style="list-style-type: none"> · Inspect and fix the cause of the lost flow · Supply the water to the tank · Clean the evaporator and condenser

9 Self-diagnostic code

Alarm display	Problem	Cause	Corrective action
	High pressure	<ul style="list-style-type: none"> · Too high ambient temperature · Too high water temperature 	<ul style="list-style-type: none"> · Do not run the machine when ambient temperature is higher than 113°F(45°C) · Contact the service agency · Check the fan running
 (Optional)	Refrigerant low pressure switch	Refrigerant leakage or shortage	<ul style="list-style-type: none"> · Replace low pressure switch · Contact the service agency
	Too high inlet Water temperature	<ul style="list-style-type: none"> · Not cooling properly · Refrigerant shortage · Water inlet temperature is higher than 45°C 	<ul style="list-style-type: none"> · Contact the service agency
	Abnormal temperature sensor	cut out or connection failure of TH1(outlet) sensor	<ul style="list-style-type: none"> · Contact the service agency
	Abnormal temperature sensor	cut out or connection failure of TH2(inlet) sensor	<ul style="list-style-type: none"> · Contact the service agency
	Abnormal temperature sensor	cut out or connection failure of TH3(Anti freeze) sensor	<ul style="list-style-type: none"> · Contact the service agency
	Anti freeze sensor activated	<ul style="list-style-type: none"> · Too low temperature on evaporator or condenser · Refrigerant shortage 	<ul style="list-style-type: none"> · Operate under 41~113°F (5 ~ 45°C) · Contact the service agency

10 Circuit diagram

WWC-500

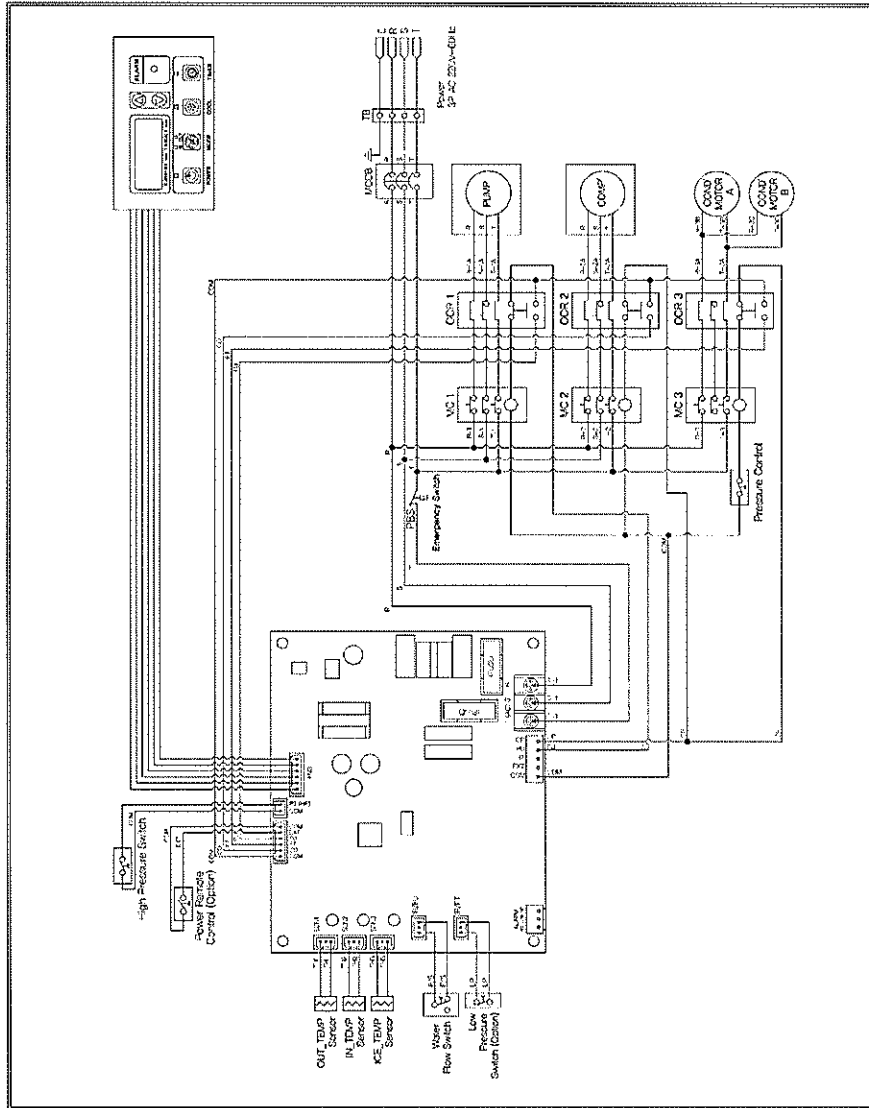

ii Model specification

Model	WWC-500
Rated power	220V / 60Hz
Cooling capacity	59600 BTU
Compressor	3phase scroll
Power consumption	7,05 Kw
Current consumption	18,5 Amps
Tank capacity(L)	65
Operation range (ambient temperature) °F (°C)	41~113 (5~45)
Operation range (water inlet temperature) °F (°C)	41~86 (5~30)
Refrigerant type oz (kg)	R-410A 130,5 (3,7)
Pump HP	1 HP
Design flow rate	39 gpm
Weight Lbs (kg)	551,2 (250)
Dimensions W x D x H – in. (mm)	26.8 x 48.8 x 52 (680 x 1240 x 1320)
Using fluid	distilled water, tap water(mix with 10% anti freeze)

※ Tested under condition

- Ambient temperature : 95°F(35°C) / 40%
- Inlet water temperature : 53.6°F(12°C)

SHIPPING LIST

- (1) Water chiller
- (1) Owner's Manual

OBTAINING SERVICE

If the Weltem Water chiller by AmeriCool requires Service:

1. Use the TROUBLESHOOTING section in this manual to eliminate obvious causes.
2. Verify there are no circuit breakers tripped.
3. Call your dealer for assistance. If you cannot reach your dealer, or if they cannot resolve the problem, call Weltem Water chiller by AmeriCool Technical Support at 888-726-6158 Please have the following information available BEFORE calling the Technical Support Department:
 - a. Your name and address.
 - b. The serial number of the unit.
 - c. Where and when the unit was purchased.
 - d. All of the model information about your Weltem Water chiller by AmeriCool.
 - e. Any information on the failure, including LED's that may or may not be illuminated.
 - f. A description of the protected equipment, including model numbers if possible.

LIMITED WARRANTY

AmeriCool warrants all AmeriCool products to be free from defects in materials or workmanship, under normal use and service, for a period of 12 months from the date of purchase to the end user (original invoice must be provided). AmeriCool warrants that the compressor will be free from defects in materials and workmanship for 12 months from the date of purchase to the end user.

AmeriCool's obligation under this warranty is limited to the repair or replacement at its option, of any part or parts, which, upon AmeriCool's examination are shown to be defective, or at AmeriCool's option, the return of the purchase price to the purchaser.

Correction of such defects by repair or replacement, or at AmeriCool's option, the return of the purchase price shall constitute fulfillment of warranty obligations to the purchaser. This warranty does not cover defects or malfunctions which result from causes beyond AmeriCool's control, including, without limitation, (i) unusual physical or electrical stress; (ii) accident, neglect, abuse, misuse or other abnormal use; (iii) failure to perform routine maintenance in accordance with AmeriCool's recommended procedures; (iv) normal wear and tear; (v) repairs or attempted repairs by an unauthorized person; (vi) modifications or alterations to the Products; (vii) use with parts or devices not supplied or approved by AmeriCool (viii) improper installation or service; (ix) shipping damage to any units or spare parts during shipping. This includes and is not limited to compressors, evaporators and condenser coils. This warranty shall extend only to the original end-user and shall be void if any labels or other identifying marks permanently affixed to Products when shipped by AmeriCool are removed, altered, defaced or obliterated.

TO THE EXTENT PERMITTED BY LAW, THIS WARRANTY, AS LIMITED HEREIN, SHALL BE IN LIEU OF AND EXCLUSIVE OF ALL OTHER WARRANTIES, EITHER EXPRESSED OR IMPLIED, ON THE PART OF AMERICOOOL INC., OR WELTEM CO., LTD. WHETHER ARISING FROM LAW, COURSE OF DEALING, USAGE OF TRADE, OR OTHERWISE, INCLUDING WITHOUT LIMITATION ANY IMPLIED WARRANTY OF MERCHANTABILITY OR FITNESS OF A PARTICULAR PURPOSE OR ANY LIABILITY FOR COMMERCIAL LOSSES BASED UPON NEGLIGENCE OR MANUFACTURER'S STRICT LIABILITY. EXCEPT AS EXPRESSLY PROVIDED HEREIN, NEITHER AMERICOOOL, INC., NOR WELTEM CO., LTD. WILL, IN ANY EVENT, BE LIABLE FOR LOST PROFITS, COSTS OF PROCESSING, INJURY, GOODWILL, OR ANY OTHER CONSEQUENTIAL DAMAGES OF ANY KIND ARISING FROM BREACH OF THIS WARRANTY.

**Manufactured in Weltem Co., Ltd.,
154, Jayumyeok 3-gil, Masanhoewon-gu, Changwon-City, Gyeongsangnam-do,
Republic of KOREA 51340 www.weltem.com**

**Distributed by Americool, Inc. In the USA (Tel.888-726-6158)
WWW.AMERICOOOLLLC.COM**